



**Demo Board for LED Dot
Matrix Based on HT1632C
User's Guide**

Table of Contents

Chapter 1. Overview	1
1.1 Overview	1
1.2 Quick Start	2
1.2.1 Power Supply	2
1.2.2 Preparation	2
1.2.3 Control Character Display	2
1.2.4 Connection and Operation Steps of One 3208 Info Board	2
1.2.5 Connection and Operation Steps of Two 3208 Info Boards	6
1.2.6 Connection and Operation Steps of Three 3208 Info Boards	7
1.2.7 Connection and Operation Steps of Four 3208 Info Boards	7
1.2.8 Connection and Operation Steps of Eight 3208 Info Boards	8
1.2.9 Connection and Operation Steps of One 2416 Info Board	8
1.2.10 Connection and Operation Steps of One 3216 Info Board	12
Chapter 2. Hardware Detail	15
2.1 Hardware Information	15
2.2 Definition of BR1 and BR2	15
Chapter 3. Electrical Characteristics	16
3.1 Power Supply	16
3.2 Heat Dissipation	16
Chapter 4. Mechanical Drawing	18
Chapter 5. Appendix	19
Chapter 6. Caution	23
Chapter 7. Contact Us	24

Demo Board for LED Dot Matrix Based on HT1632C

NOTES:

Product Version : Ver 1.1

Document Version : Ver 2.0

Chapter 1. Overview

1.1 Overview

Thanks for using the demo driver board for 3208 Dot-Matrix LED Board of Sure Electronics. This driver board can be used to test and control 3208 info boards. UART-based communication and HMI-based software--**Sure-LEDV1.0** allow the scrolling display of ASCII characters. It also can be used to test 2416 info board and 3216 info board. Users can refer to the following table for the type of Dot-Matrix LED Board products.

TABLE 1-1 DOT MATRIX LED INFORMATION BOARD

Product Number	Product Name
DE-DP13111	P4 32X8 Green LED Dot Matrix Unit Board
DE-DP13112	P4 32X8 Red LED Dot Matrix Unit Board
DE-DP13211	P7.62 32X8 Green LED Dot Matrix Unit Board
DE-DP13212	P7.62 32X8 Red LED Dot Matrix Unit Board
DE-DP11111	P4 24X16 Green LED Dot Matrix Unit Board
DE-DP11112	P4 24X16 Red LED Dot Matrix Unit Board
DE-DP11211	P7.62 24X16 Green LED Dot Matrix Unit Board
DE-DP11212	P7.62 24X16 Red LED Dot Matrix Unit Board
DE-DP14112	P4 32X16 RG Bicolor LED Dot Matrix Unit Board
DE-DP14211	P7.62 32X16 RG Bicolor LED Dot Matrix Unit Board

FIGURE 1-1 OVERVIEW

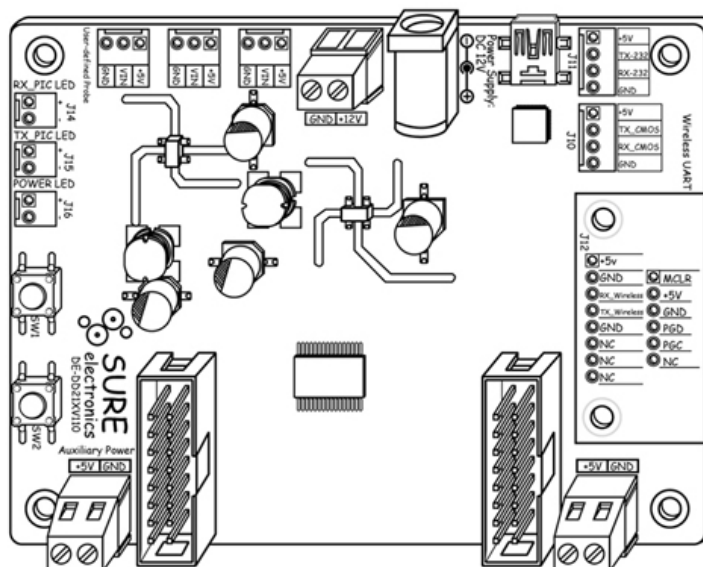

This driver boards support UART communication. Users can download the software Sure-LEDV1.0 via the address as follows:

<http://www.sure-electronics.net/download/index.php?name=de-dd210&type=0>

Download and unzip Sure_LED_1.0.zip, then double-click Sure-LED v1.0.exe and the simulation screen of info board is as shown in figure 1-2.

Demo Board for LED Dot Matrix Based on HT1632C

FIGURE 1-2 THE SIMULATION SCREEN OF INFO BOARD

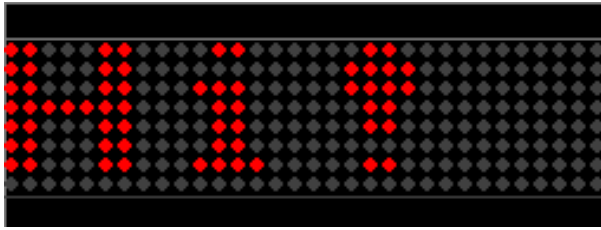

Note: CP2102 driver must be installed to realize the UART communication between the demo driver board and PC via a USB interface. It can be downloaded from the following address:

<http://www.sureelectronics.net/goods.php?id=393>

Download and unzip [CP210x_VCP_Win2K_XP_S2K3.zip](#), and then run CP210x_VCP_Win2K_XP_S2K3.exe

1.2 Quick Start

1.2.1 Power Supply

12V/3A power supply is recommended.

1.2.2 Preparation

CP2102 driver and the HMI-based software Sure-LEDV1.0 must be installed before the communication via the USB interface.

1.2.3 Control Character Display

This driver board is able to control the ASCII characters display of 1, 2, 3, 4 and 8 pieces 3208 info boards which are connected in series.

1.2.4 Connection and Operation Steps of One 3208 Info Board

1. As shown in figure 1-3, connect the driver board and the 3208 info board with a 16-pin IDC cable via BR1 and set the CS1 of SW1 of the info board ON.

FIGURE 1-3 CONNECTION OF THE DRIVER BOARD AND ONE INFO BOARD

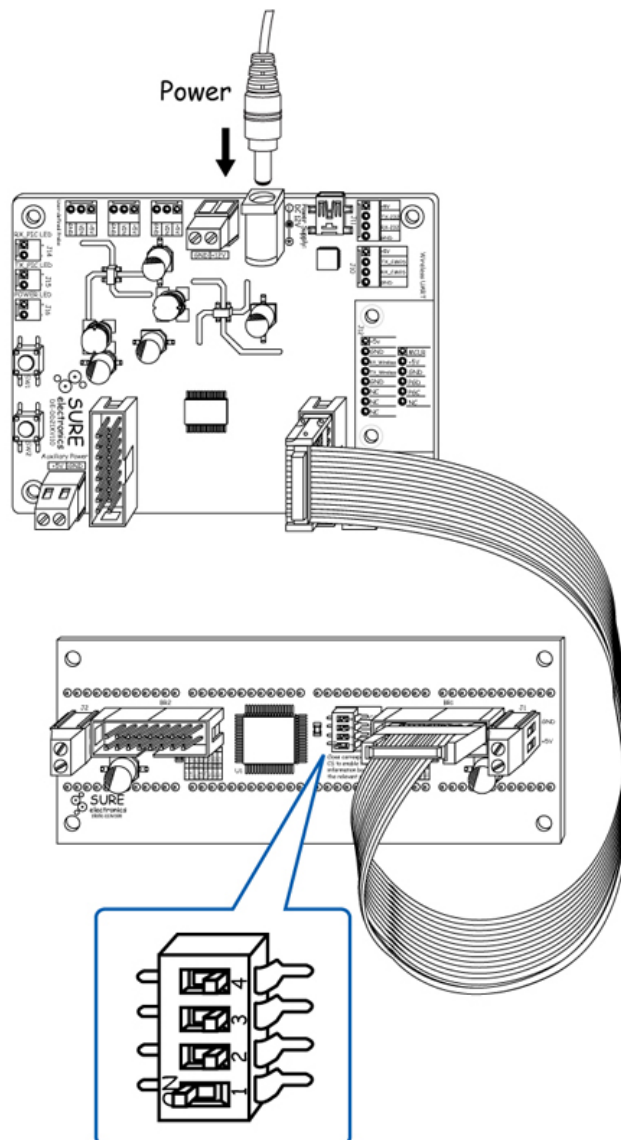

2. Power the driver board and the info board will display "3208" as shown in figure 1-4

FIGURE 1-4 DISPLAY SAMPLE OF "3208"

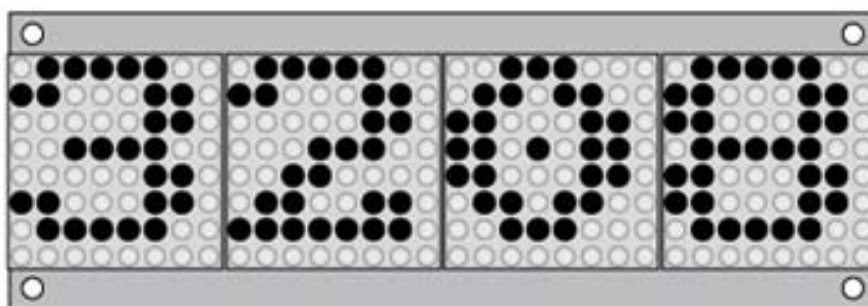

3. Press the SW2 of driver board six times to test the info board and the info board will be correspondingly in six modes: totally going out, fully lighting, odd columns' LEDs lighting, even columns' LEDs lighting, odd lines' LEDs lighting, even lines' LEDs lighting in succession, as shown in figure 1-5. Continue pressing SW2 and the info board will display the number of the info board. "0001" is the default.

Demo Board for LED Dot Matrix Based on HT1632C

FIGURE 1-5 TESTING SAMPLE

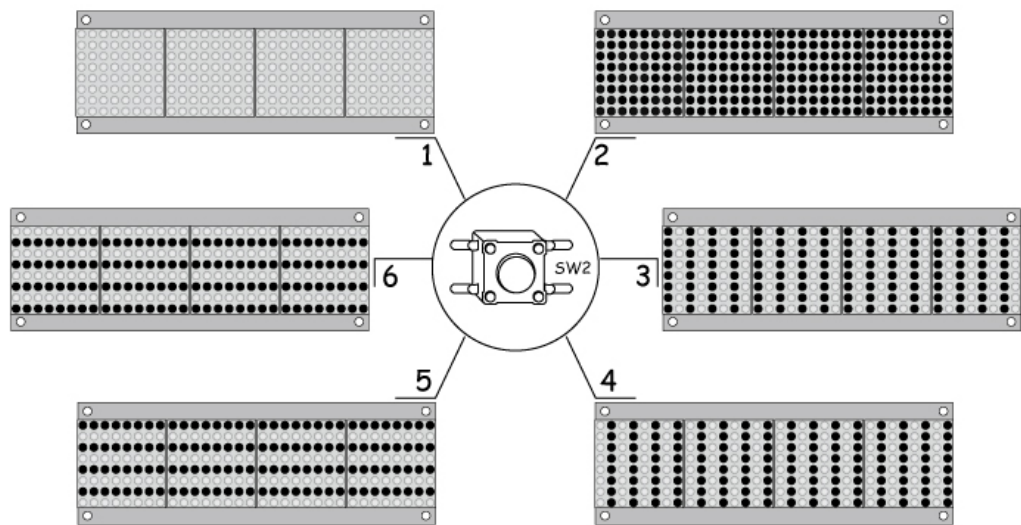

Note: If you don't press SW2 after power-on, the info board will automatically switch the modes one by one as shown in figure 1-5.

4. Select "0001" and then press SW1. The info board will show the scrolling LED display of the characters "Sure Electronics" and then stop with the display of "Wait".

FIGURE 1-6 DISPLAY SAMPLE OF "WAIT"

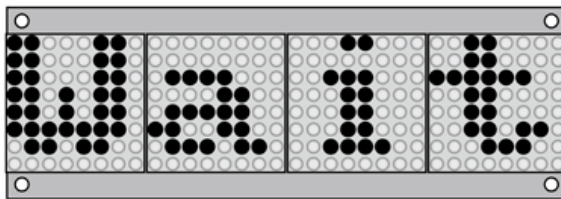

5. Connect the driver board and PC with a USB cable as shown in figure 1-7. Double-click Sure-LED V1.0.exe and a simulation screen will pop up as shown in figure 1-8:

FIGURE 1-7 CONNECTION SCHEMATICS OF THE DRIVER BOARD AND PC

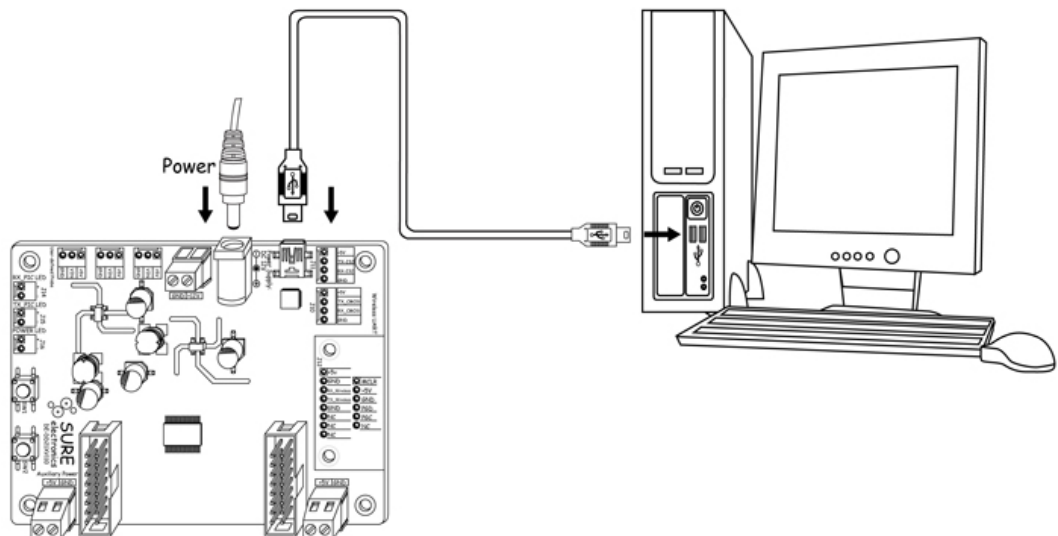
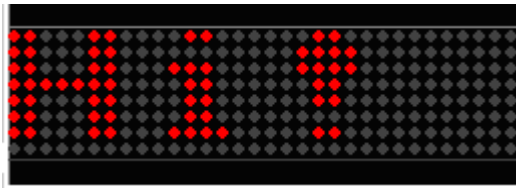

FIGURE 1-8 SIMULATION SCREEN



Right-click the simulation screen and select “Config” and then a configuration window pops up. Select “1*4” from the pull-down list of “Screen Size” under “Setting” to simulate the display of 4 characters in one row.

Select “Red” from the pull-down list of “LED Color” under “Setting”. You can also select other two colors-green and yellow according to the info board’s color or the color you like.

Choose COM3 port to realize the communication between the driver board and PC. Please refer to [Chapter 6](#) for detailed information.

Note: The COM port referred in this manual is COM3. Please select the right COM port according to your own PC.

Click “Apply” and the info board will synchronously display the characters on PC.

6. Type in new characters to be displayed in the textbox under “Display” in configuration window as shown in figure 1-9. Click “Apply” and the info board will display the new characters typed in as shown in figure 1-10.

FIGURE 1-9 TYPE IN THE CHARACTERS

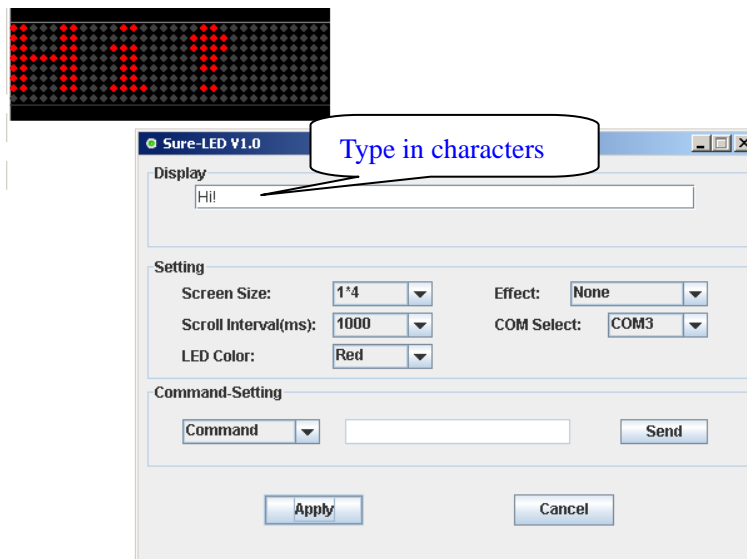

Demo Board for LED Dot Matrix Based on HT1632C

FIGURE 1-10 DISPLAY SAMPLE OF “SURE”

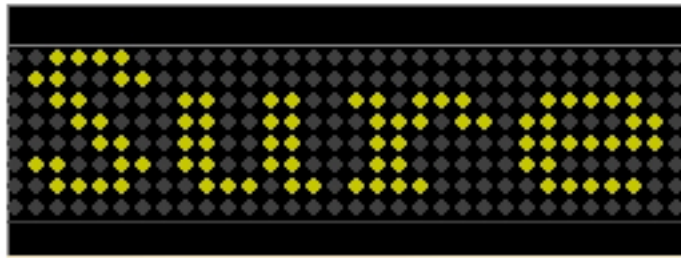

Simulation Screen

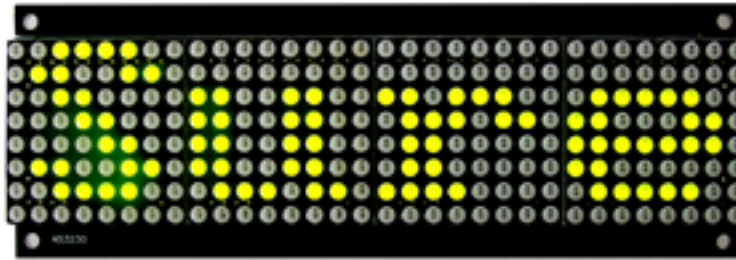

1.2.5 Connection and Operation Steps of Two 3208 Info Boards

1. As shown in figure 1-11, connect two 3208 info boards and BR1 socket of the driver board with two 16-pin IDC cables and set the CS1 of SW1 of the first info board and CS2 of the second info board ON.

FIGURE 1-11 CONNECTION SCHEMATICS

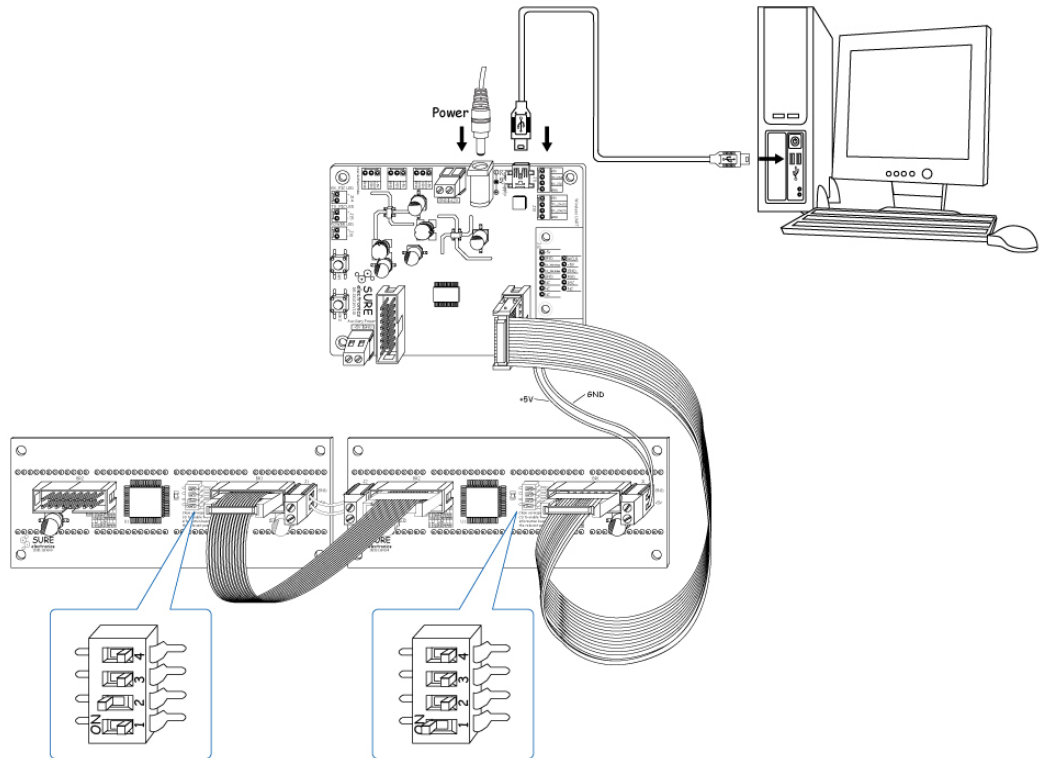

2. Power the driver board and all the info boards will display “3208”. The display sample is the same as shown in figure 1-4.

3. Press the SW2 of the driver board six times to test the info board and the info board will be correspondingly in six modes: totally going out, fully lighting, odd columns’ LEDs

lighting, even columns' LEDs lighting, odd lines' LEDs lighting, even lines' LEDs lighting in succession as shown in figure 1-5.

4. Continue to press SW2 and select "0002" and then press SW1. The info boards will show the scrolling LED display of the characters "Sure Electronics" and then will stop with the display of "Waiting" as shown in figure 1-12.

FIGURE 1-12 DISPLAY SAMPLE OF "WAITING"

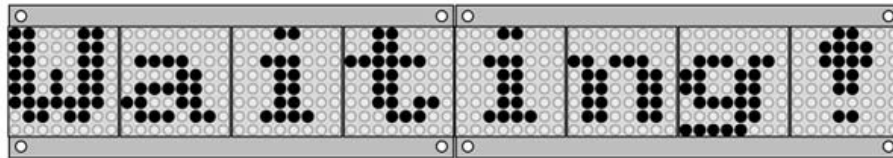

5. Double-click Sure-LED V1.0.exe and a simulation screen will pop up. Right-click the simulation screen and select "Config" and then a configuration window pops up. Select "1*8", "Red", "COM3" and click "Apply". The info boards will synchronously display the characters on PC.

6. Type in new characters to be displayed in the textbox and then click "Apply". The info board will synchronously display the new characters.

1.2.6 Connection and Operation Steps of Three 3208 Info Boards

1. Connect three 3208 info boards and BR1 socket of the driver board with three 16-pin IDC cables and set the CS1 of the first info board, CS2 of the second info board and CS3 of the third info board ON. The connection is the same as shown in figure 1-11.

2. Power the driver board and all the info boards will display "3208". The display sample is the same as shown in figure 1-4.

3. Press the SW2 of the driver board six times to test the info board and the info board will be correspondingly in six modes: totally going out, fully lighting, odd columns' LEDs lighting, even columns' LEDs lighting, odd lines' LEDs lighting, even lines' LEDs lighting in succession as shown in figure 1-5.

4. Continue to press SW2 and select "0003" and then press SW1. The info boards will show the scrolling LED display of the characters "Sure Electronics" and then will stop with the display of "Waiting", the same sample as shown in figure 1-12.

5. Double-click Sure-LED V1.0.exe and a simulation screen will pop up. Right-click the simulation screen and select "Config" and then a configuration window pops up. Select "1*12", "Red", "COM3" and click "Apply". The info boards will synchronously display the characters on PC.

6. Type in new characters to be displayed in the textbox and then click "Apply". The info board will synchronously display the new characters.

1.2.7 Connection and Operation Steps of Four 3208 Info Boards

1. Connect four 3208 info boards and BR1 socket of the driver board with four 16-pin IDC cables and set the CS1 of the first info board, CS2 of the second info board, CS3 of the third info board, CS4 of the fourth info board ON. The connection is the same as shown in figure 1-11.

2. Power the driver board and all the info boards will display "3208". The display sample is the same as shown in figure 1-4.

3. Press the SW2 of the driver board six times to test the info board and the info board will be correspondingly in six modes: totally going out, fully lighting, odd columns' LEDs lighting, even columns' LEDs lighting, odd lines' LEDs lighting, even lines' LEDs lighting

Demo Board for LED Dot Matrix Based on HT1632C

in succession as shown in figure 1-5.

4. Continue to press SW2 and select "0004" and then press SW1. The info boards will show the scrolling LED display of the characters "Sure Electronics" and then will stop with the display of "Waiting", the same sample as shown in figure 1-12.

5. Double-click Sure-LED V1.0.exe and a simulation screen will pop up. Right-click the simulation screen and select "Config" and then a configuration window pops up. Select "1*16", "Red", "COM3" and click "Apply". The info boards will synchronously display the characters on PC.

6. Type in new characters to be displayed in the textbox and then click "Apply". The info board will synchronously display the new characters.

1.2.8 Connection and Operation Steps of Eight 3208 Info Boards

1. Connect four 3208 info boards and BR1 socket of the driver board with four 16-pin IDC cables and set the corresponding CS1, CS2, CS3 and CS4 of the four info boards ON. Connect four 3208 info boards and BR2 socket of the driver board with four 16-pin IDC cables and set the corresponding CS1, CS2, CS3 and CS4 of the four info boards ON. The connection is the same as shown in figure 1-11.

2. Power the driver board and all the info boards will display "3208". The display sample is the same as shown in figure 1-4.

3. Press the SW2 of the driver board six times to test the info board and the info board will be correspondingly in six modes: totally going out, fully lighting, odd columns' LEDs lighting, even columns' LEDs lighting, odd lines' LEDs lighting, even lines' LEDs lighting in succession as shown in figure 1-5.

4. Continue to press SW2 and select "0008" and then press SW1. The first row of info boards will display characters "Welcome to" and the second row will display characters "Sure Electronics".

5. Double-click Sure-LED V1.0.exe and a simulation screen will pop up. Right-click the simulation screen and select "Config" and then a configuration window pops up. Select "2*16", "Red", "COM3" and click "Apply". The info boards will synchronously display the characters on PC.

6. Type in new characters to be displayed in the textbox and then click "Apply". The info board will synchronously display the new characters.

1.2.9 Connection and Operation Steps of One 2416 Info Board

This driver board can also be used to test 2416 info boards. Connection and operation steps are as follows.

1. As shown in figure 1-13 and figure 1-14, connect the driver board and the 2416 info board with a 16-pin IDC cable and set the CS1 of SW1 of the info board ON.

FIGURE 1-13 CONNECTION SCHEMATICS OF THE DRIVER BOARD AND THE 2416 3MM INFO BOARD

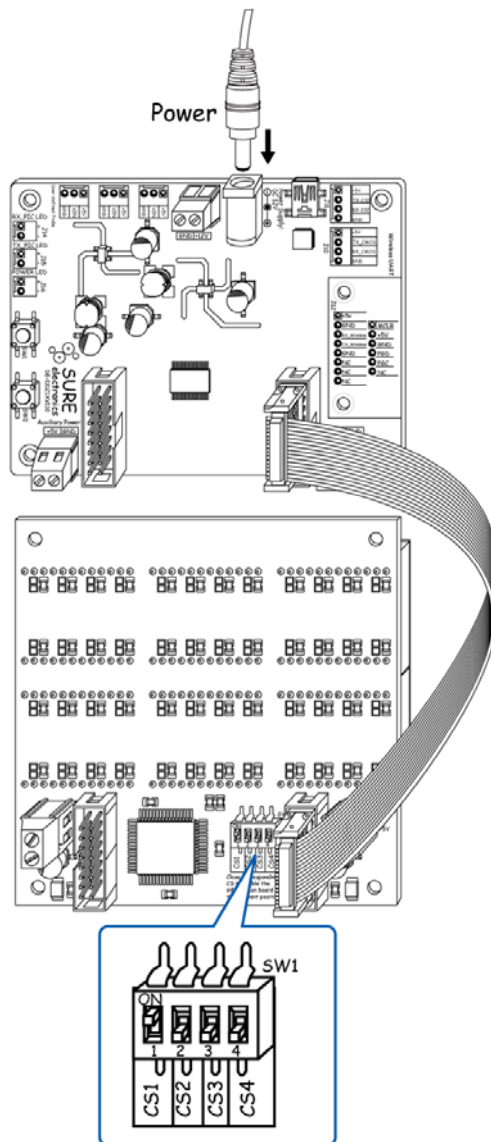

Demo Board for LED Dot Matrix Based on HT1632C

FIGURE 1-14 CONNECTION SCHEMATICS OF THE DRIVER BOARD AND THE 2416 5MM INFO BOARD

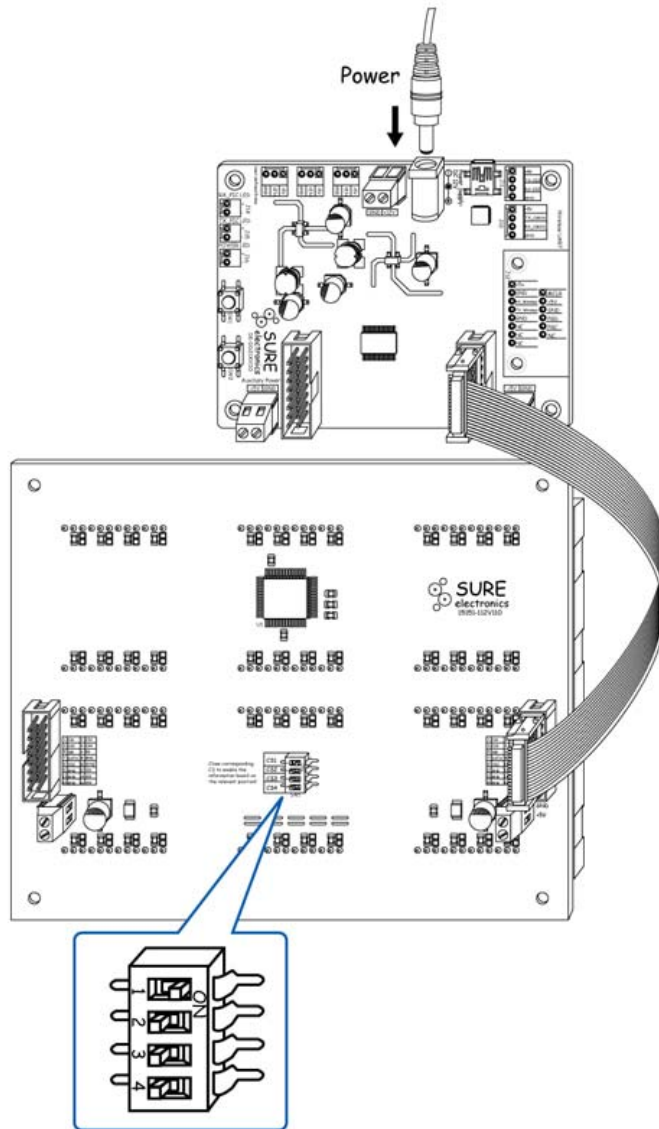

2. Power the driver board and each LED display board display chaotic numbers. Press SW1 within 1 second and the first row of the 2416 info board will display "24" and the second row "16". The sample is as follows:

FIGURE 1-15 DISPLAY SAMPLE OF “24” AND “16”

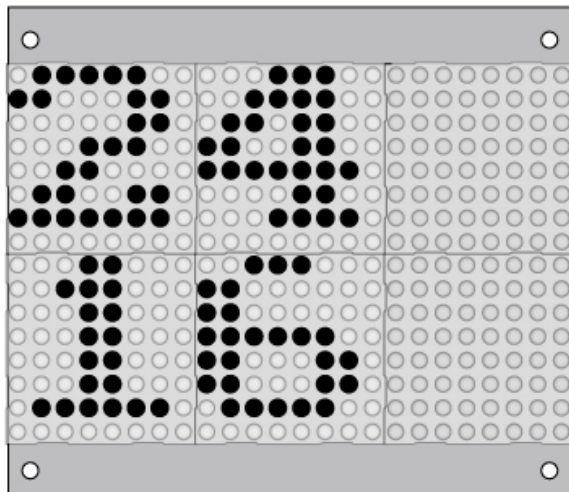

3. Press the SW2 of the driver board six times to test the info board and the info board will be correspondingly in six modes: totally going out, fully lighting, odd columns' LEDs lighting, even columns' LEDs lighting, odd lines' LEDs lighting, even lines' LEDs lighting in succession as shown in figure 1-16. Continue to press SW2 and the first row of the info board will display “OK!” and the second row will show the scrolling LED display of the characters “Sure Electronics” as shown in figure 1-17.

FIGURE 1-16 TESTING SAMPLE

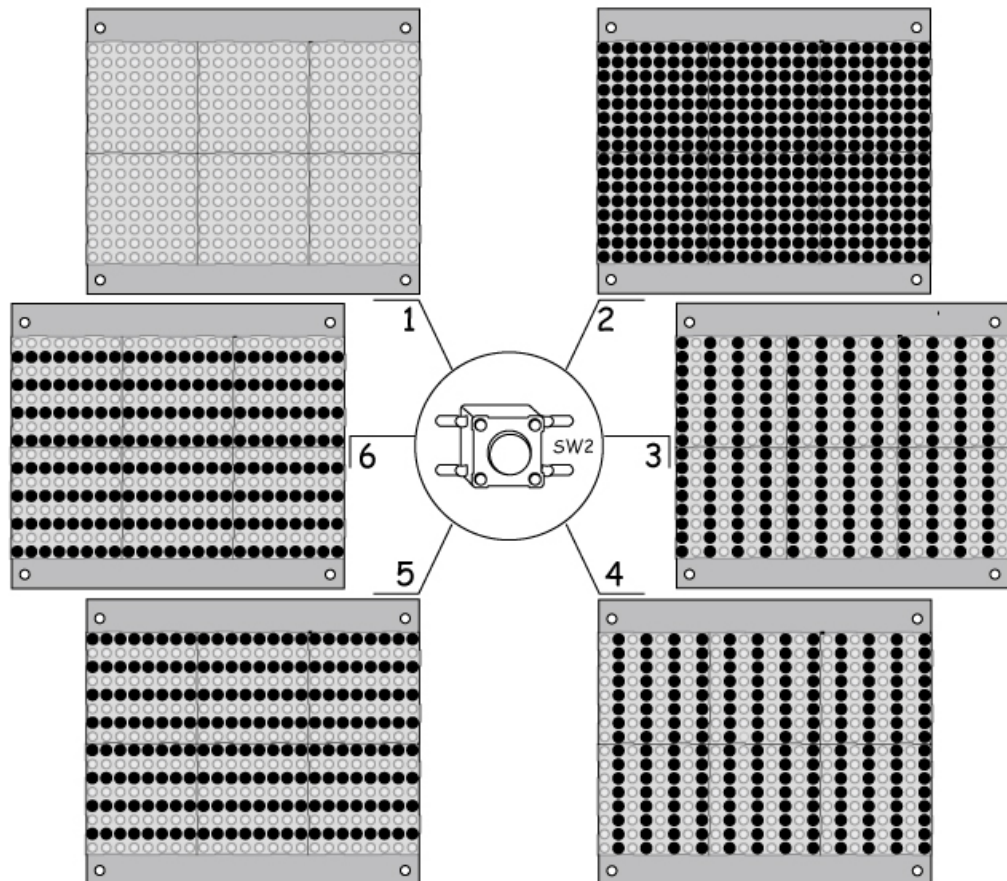

Demo Board for LED Dot Matrix Based on HT1632C

FIGURE 1-17 DISPLAY SAMPLE OF “OK!” AND “SURE ELECTRONICS”

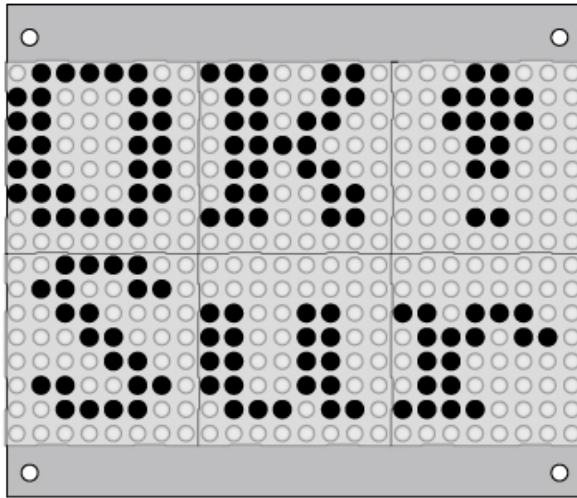

1.2.10 Connection and Operation Steps of One 3216 Info Board

This driver board can also be used to test 3216 info boards. Connection and operation steps are as follows.

1. As shown in figure 1-18 and figure 1-19, connect BR1 of the driver board and the input of the 3216 info board with a 16-pin IDC cable.

FIGURE 1-18 CONNECTION SCHEMATICS OF THE DRIVER BOARD AND THE 3216 3MM INFO BOARD

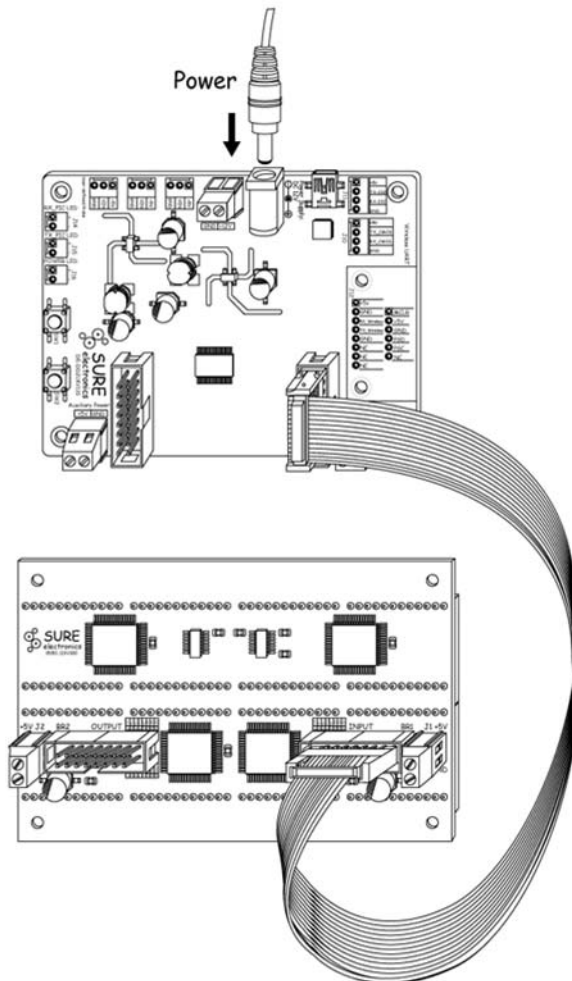
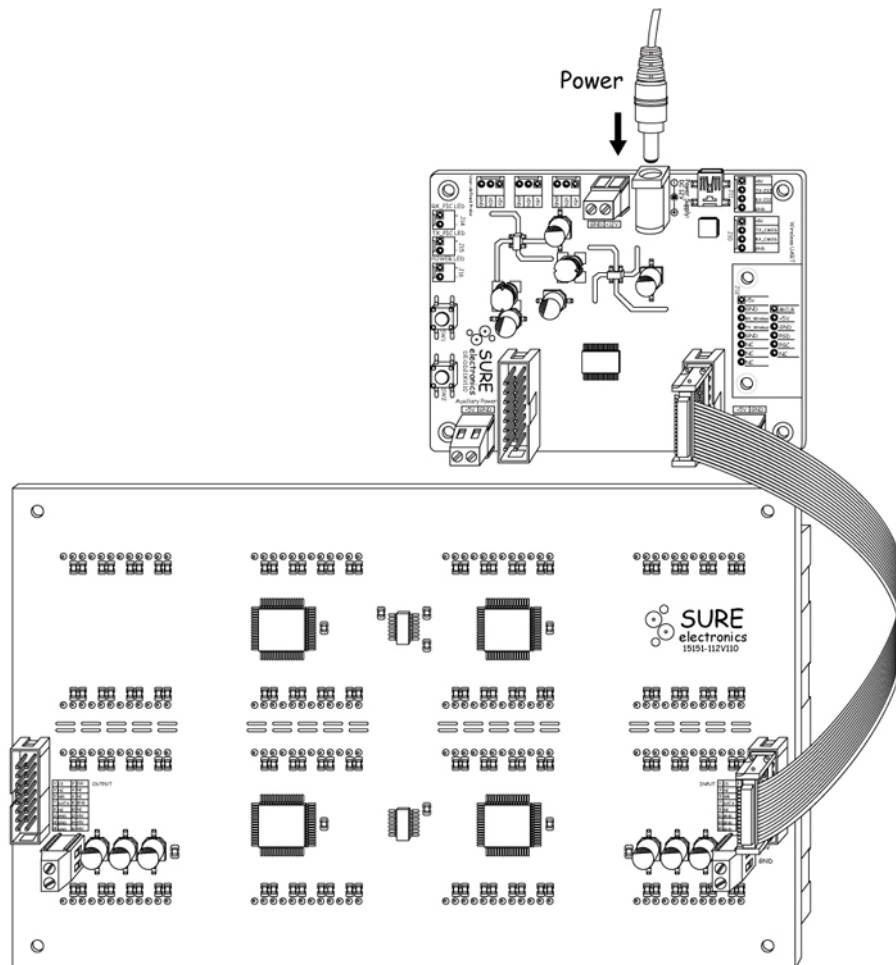
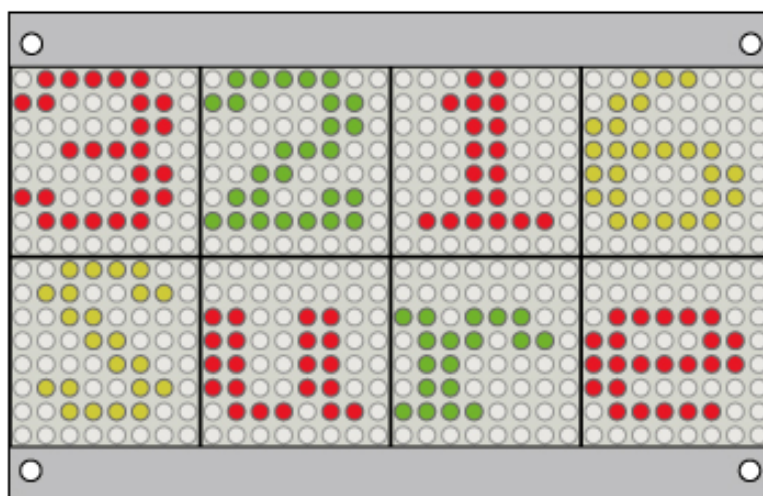

FIGURE 1-19 CONNECTION SCHEMATICS OF THE DRIVER BOARD AND THE 3216 5MM INFO BOARD



2. Power the driver board. Press SW1 more than 1 second and the first row of the 3216 info board will display “3216” and the second row “Sure”. The sample is as follows:

FIGURE 1-20 DISPLAY SAMPLE OF “3216” AND “SURE”



3. Press the SW2 of the driver board six times to test the info board and the info board will be correspondingly in six modes: totally going out, fully lighting, odd columns’ LEDs lighting, even columns’ LEDs lighting, odd lines’ LEDs lighting, even lines’ LEDs lighting in succession as shown in figure 1-21.

Demo Board for LED Dot Matrix Based on HT1632C

FIGURE 1-21 TESTING SAMPLE

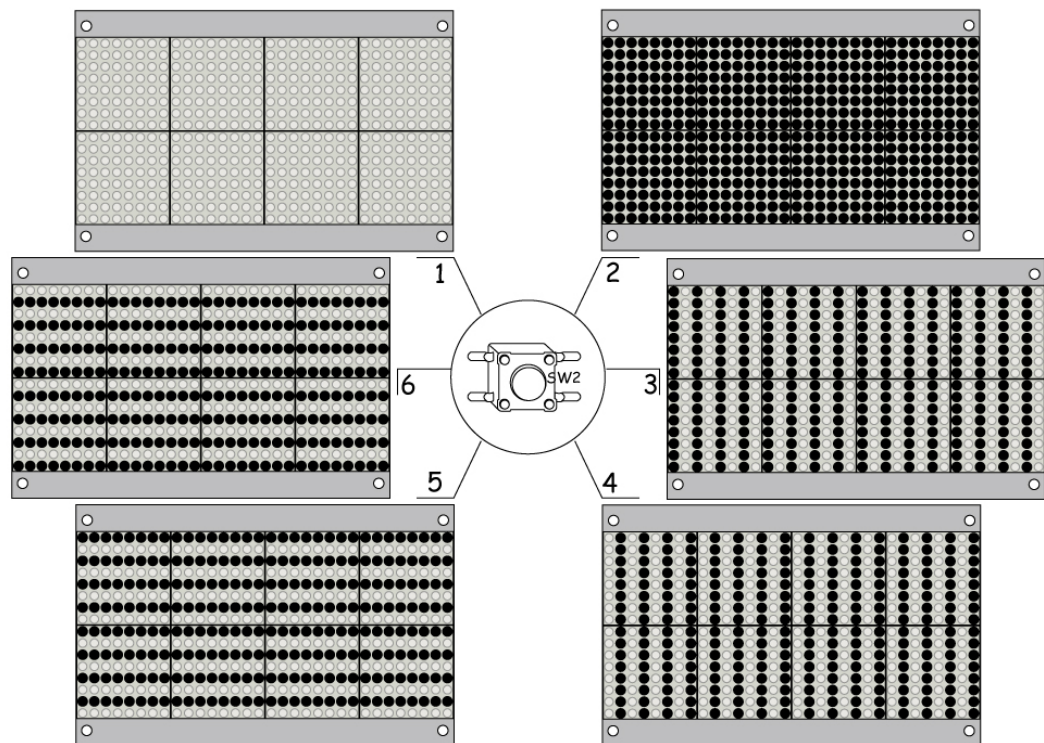

Chapter 2. Hardware Detail

2.1 Hardware Information

1. Control chip U7: PIC16F723, SOIC packaging.
2. 5-pin Mini-B USB plug J11 used for UART communication; SMT-based Mini USB connector.
3. USB Communication Signal Conversion chip: CP2102, QFN packaging.
4. 12V/3A Input Socket
5. 6-pin SMT-based AX3022 step-down DC/DC converter chip in SOT89-5L packaging.
6. Plugs for connecting the Dot-Matrix LED info boards: BR1 and BR2.
7. J7 and J8 are used to assist power output.

2.2 Definition of BR1 and BR2

TABLE 2-1 DEFINITION OF BR1

No	Port Name	Function
1	CS2	Chip Selection 2
2	CS3	Chip Selection 3
3	CS1	Chip Selection 1
4	CS4	Chip Selection 4
5	CLK	Clock Line
6, 9, 10	NC	No Connection
7	DATA	Data Line
8, 11, 13, 15	GND	Ground
12, 14, 16	+5V	The Positive Power Supply

TABLE 2-2 DEFINITION OF BR2

No	Port Name	Function
1	CS6	Chip Selection 6
2	CS5	Chip Selection 5
3	CS7	Chip Selection 7
4	CS8	Chip Selection 8
5	CLK	Clock Line
6, 9, 10	NC	No Connection
7	DATA	Data Line
8, 11, 13, 15	GND	Ground
12, 14, 16	+5V	The Positive of Power Supply

Chapter 3. Electrical Characteristics

3.1 Power Supply

Voltage input range: 8V-24V.

3.2 Heat Dissipation

Figure 3-1 and figure 3-2 are pictures of heat dissipation gained by Fluke Ti20 Thermal Imager after nearly 3-hours continuous working of 8 pcs 0832 boards.

Test Conditions:	
Ambient Temp	26°C
PWM duty cycle	100%
Time elapsed	3 hours
12V DC power supply	
All LEDs are illuminated	

FIGURE 3-1 HEAT DISTRIBUTION OF THE FRONT PANEL

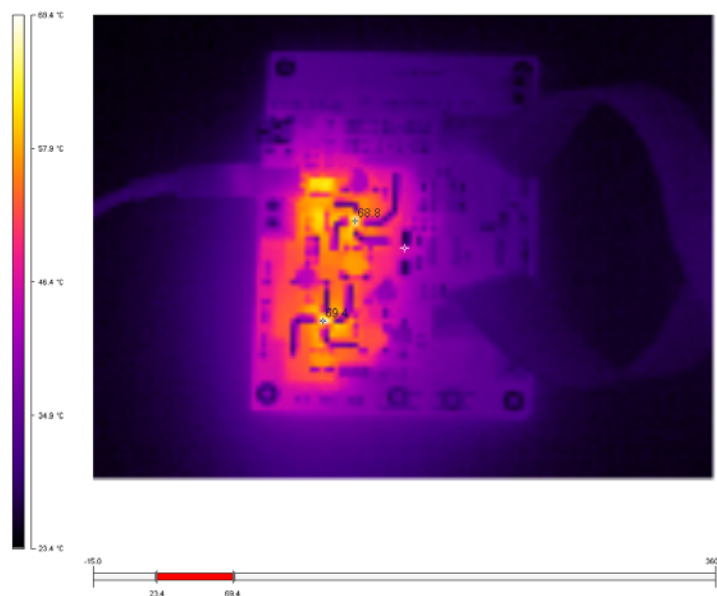

Demo Board for LED Dot Matrix Based on HT1632C

FIGURE 3-2 HEAT DISTRIBUTION OF THE BACK PANEL

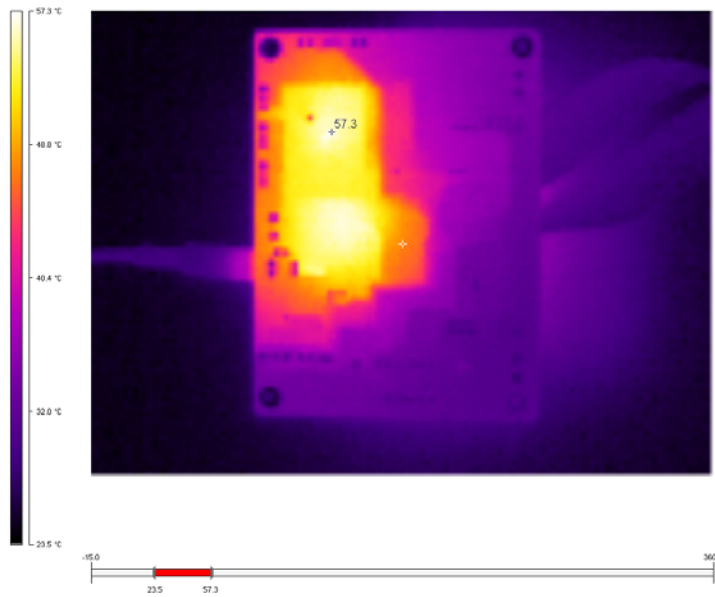

Chapter 4. Mechanical Drawing

FIGURE 4-1 MECHANICAL DRAWING

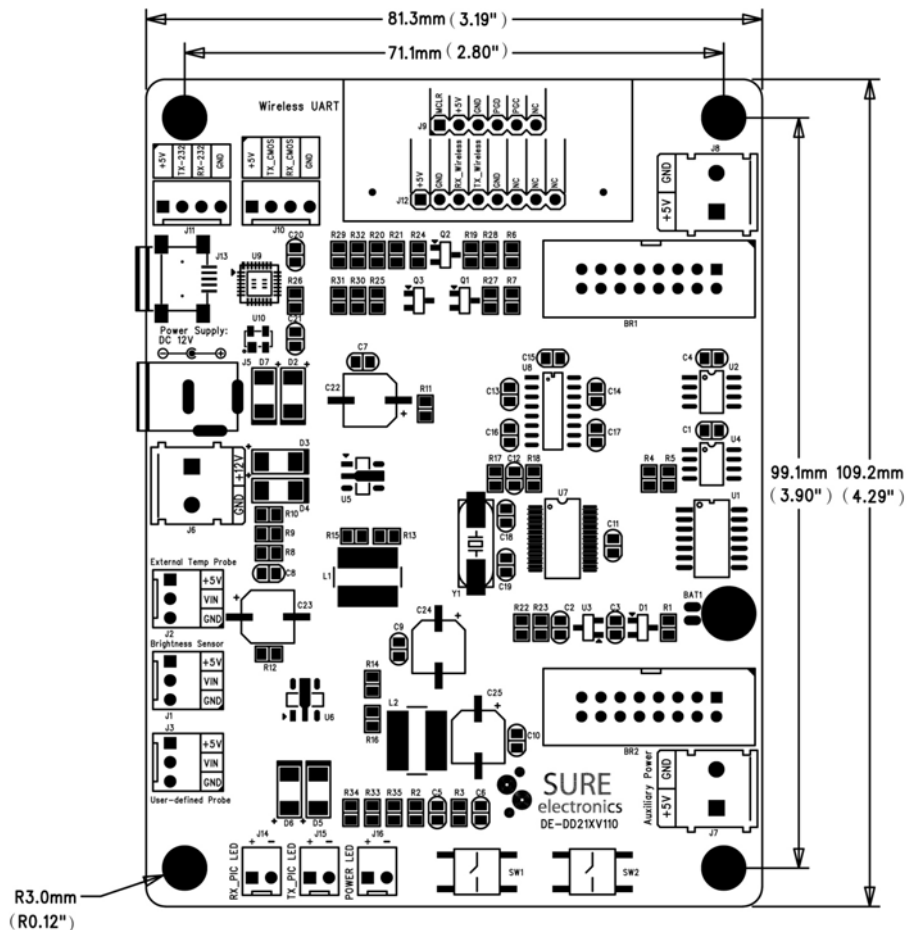

Chapter 5. Appendix

Sample Code:

This program reads and writes data of HT1632C by the ways of SPI and GPIO. When the control commands for HT1632C are not in the same length, GPIO will be applied. Please refer to table 5-1 for specific codes which is as the reference for 3208 and 2416 info boards. Please refer to the manual of 3216 info boards for sample codes for driving 3216 info boards.

TABLE 5-1 WRITE CONTROL COMMANDS DATA

```

/*****
Function name: write command function
Function feature: write control commands to HT1632C
Input argument: command words written to "command", specifically stated in "declare" function
Output argument: void
*****/
void Command_Write_HT1632C(unsigned int command)
{
    unsigned char i;
    unsigned int j;
    command=command&0x0fff;           // 12-bit command word
    CS_OFF;                           // the control character 1; disable HI1632C

    CLK_DELAY;
    CS_ON                             // enable HI1632C
    CLK_DELAY;
    for(i=0;i<12;i++)                // write the command word in HI1632C register
    {
        CLK=0;
        CLK_DELAY;
        j=command & 0x0800;          // return the MSB
        command=command<<1;         // move the control character to the left one
        j=j>>11;                     // position the value at the LSB
        DAT=j;                       // send the value to the data port
        CLK_DELAY;
        CLK=1;                       // data transmission (data valid on rising edge)
        CLK_DELAY;
    }
    CS_OFF;                           // finished
}

```

In order to improve the communication speed of data in HT1632C, SPI communication port of PIC16F723 is needed. Configure SPI communication and then write function in SPI data. Please refer to table 5-2 and table 5-3 for specific codes.

Demo Board for LED Dot Matrix Based on HT1632C

TABLE 5-2 SPI COMMUNICATION CONFIGURATION

```
//*****  
// Function name: SPI mode configuration  
// Function feature: configure the data transmission port of PIC microcontroller for SPI communication  
mode  
// Input argument: void  
// output argument: void  
//*****  
void SPI_Model_Configure(void)  
{  
    SSPIF=0;          // initial state: waiting to be sent  
    SSPCON=0x31;     // write in this register: SSPEN=1(enable serial port); CKP=1(CLK is high in an  
idle state); CLK is Fosc/16.  
    SSPSTAT=0x80;   // write in this register: SMP=1(Input data sampled at end of data output  
time);CKE=0(data stable on rising edge of SCK).  
}
```

TABLE 5-3 WRITE COMMUNICATION DATA

```
//*****  
// Function name: data transmission function of SPI mode  
// Function feature: transmit data in SPI mode of PIC microcontroller  
// Input argument: data: bytes of data to be transmitted  
// Output argument: void  
//*****  
void SPI_Data_send(const unsigned char data)  
{  
    SSPBUF=data;          // start sending  
    do {  
        ;  
    }while(SSPIF==0);    // wait for data being sent  
    SSPIF=0;             // clear flag  
}
```

You can write character display function after finish two functions above. Please refer to table 5-4 for details.

TABLE 5-4 CHARACTER DISPLAY FUNCTION

```
//*****  
// Function name: char display  
// Function feature: select corresponding LED board and display the char in the corresponding address  
// Input argument: cs: LED board; a: address c: char to be displayed  
// Output argument: void  
//*****  
void Display_char(unsigned char cs, unsigned char a, unsigned char c)  
{  
    unsigned char i,databuffer;  
    Address_Write_HT1632C(cs, a);          // select LED board and address
```

```

SPI_Model_Configure();
c=c-' ';
for(i=0;i<MARTRIX_PT;i++)
{
    databuffer=(AsciiDot+MARTRIX_PT*(unsigned int)c+i); // refine data value from ASCII data
table
    SPI_Data_send(databuffer); // send data in SPI mode
}
SSPCON=0x11;
}
    
```

Command Set:

No	To SCM	Means
1	start with "0xFE,0x47 (G),0x01,0x01" followed by 16 characters	display the 16 characters in the first row
2	start with "0xFE,0x47 (G),0x01,0x02" followed by 16 characters	display the 16 characters in the second row

FIGURE 5-1: SCHEMATICS 1

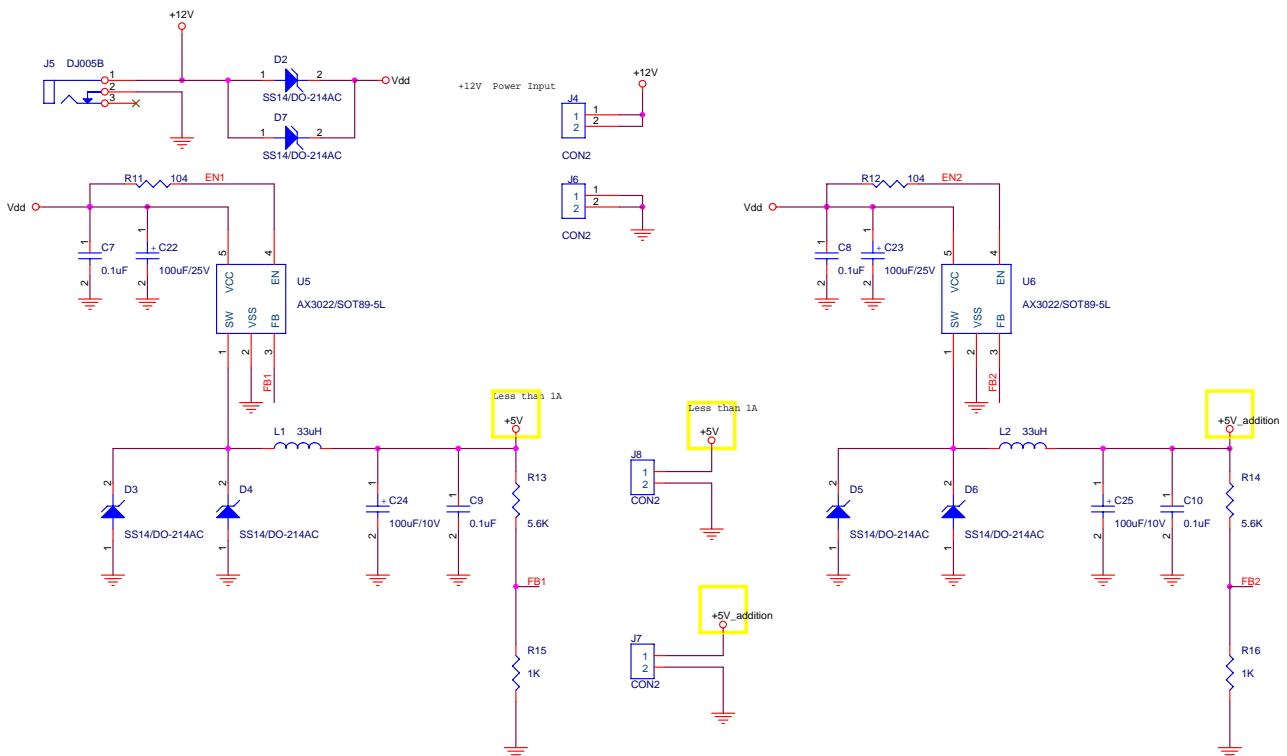

Chapter 6. Caution

1. How to find the corresponding COM port after the driver board has been connected with PC and the CP2102 driver has been installed:
 - a. Right-click "My computer" on the desktop and select "Properties".
 - b. Select "Hardware" tap.
 - c. Click "Device Manager" button and "Device Manager" window pops up. View "Ports (COM&LPT)" which shows all the COM ports connected with PC. Find the COM port corresponding to the demo driver board.
2. When the driver board operates at full load, U5, U6 and the area around them will be too hot to touch.
3. The info boards of the first row and the second row should not be cross-connected.
4. Only the display of the common ASCII characters is supported at present.
5. Please refer to "help.html" in Sure_LED_1.0.zip for how to use the software Sure-LED V1.0.exe.

Download address:

<http://www.sure-electronics.net/download/index.php?name=de-dd210&type=0>

Chapter 7. Contact Us

Sure Electronics Co., Ltd.

East zone, 3F, Building 6
Jingang Technology Innovation Center
No.108 Ganjiabian Rd (ZIP: 210000)
Qixia District
Nanjing
P.R.China

Tel: +86-25-68154800-860

Fax: +86-25-68154891-832

Website: www.sure-electronics.com

Email: customerservice@sure-electronics.com